

# COMBINED SIDERMAT DIN

Fuse combination switches with tripping function

from 800 A to 1800 A

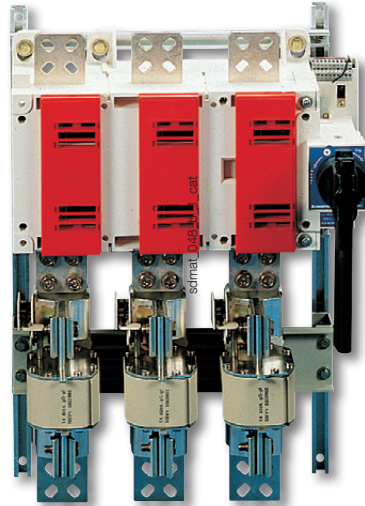

*SIDERMAT fuse-combination switches from 800 to 1800 A*

## The solution for

- > Healthcare
- > Energy
- > Infrastructure & Transport
- > Industry



## Strong points

- > Automatic tripping
- > Optimum safety
- > High breaking capacity

## Extended range

- > To use with uR fuses for the protection of power semiconductors, please consult us.

## Conformity to standards

- > IEC 60947-3
- > IEC 60269-1
- > IEC 60269-2



## Function

**COMBINED SIDERMAT DIN** are manually operated 3 or 4-pole fuse load break switches with a remote tripping function.

They provide load operation, safety disconnection and protection against overloads and shortcircuits in any low voltage electrical circuit. They can ensure the automatic opening of the circuit together with:

- fuse blown detection system (see DDMM or FMD),
- thermal relay,
- differential relay (see RESYS),
- other safety devices.

## Advantages

### Automatic tripping

COMBINED SIDERMAT DIN is the only fuse combination switch that allows automatic remote opening by means of a coil associated with an external device.

### Optimum safety

Visible double breaking indication by phase (up and downstream from the fuse) to show the actual position of contacts and keep personnel and equipment protected from overcurrent.

### High breaking capacity

High breaking capacity fuses (100 kA rms) provide protection from overloads and short circuits.

## General characteristics

- For industrial fuses up to 1800 A.
- 3P or 4P available.
- Direct or external handle.
- NFC and DIN fuses.

# COMBINED SIDERMAT DIN

Fuse combination switches with tripping function  
from 800 A to 1800 A

## Configurations

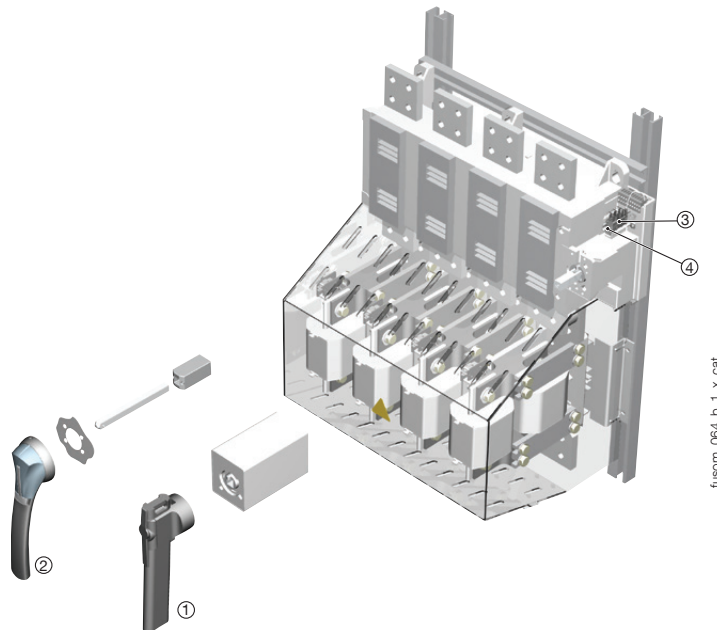

Functional diagram (for further details see the installation instructions supplied with the product).

1. Direct front operation.
2. External front operation.
3. NO/NC auxiliary contact for each position.
4. NO/NC auxiliary contact with standard shunt trip coil control.

fuscm\_064\_b\_1\_x\_cat

## References

### COMBINED SIDERMAT DIN combination switches with front operation

Device fitted with a 230 VAC shunt trip coil

Rating (A) / Fuse	No. of poles	Switch body	Direct handle	External handle	Shaft for external handle	1 <sup>st</sup> auxiliary contact position	Auxiliary contact tripping	Top terminals screen	Inter-phase barrier
800 A / 4	3 P	3520 3080	Black 3999 6203 <sup>(1)</sup>	Type S3 Black IP55 1431 3511 <sup>(1)</sup> Red IP55 1432 3511	320 mm 1401 1532	1 <sup>st</sup> NO/NC contact 3999 0051 2 <sup>nd</sup> NO/NC contact 3999 0052	1 contact NO/NC 3999 0031	3 P 2998 3120 <sup>(2)</sup> 4 P 2998 4120 <sup>(2)</sup>	3 P 2998 0003 4 P 2998 0004
	4 P	3520 6080							
1250 A / 4	3 P	3520 3120							
	4 P	3520 6120							
1600 A / 2 x 4	3 P	3520 3160							
	3 P + NC	3520 4160							
	4 P	3520 6160							
1800 A / 2 x 4	3 P	3520 3180 <sup>(3)</sup>							
	3 P + NC	3520 4180 <sup>(3)</sup>							
	4 P	3520 6180 <sup>(3)</sup>							

(1) Standard.

(2) The bottom terminal screen is delivered as standard.

(3) One of the T4 fuses is fitted with a striker.

# COMBINED SIDERMAT DIN

Fuse combination switches with tripping function  
from 800 A to 1800 A

## Accessories

### Direct handle

Front operation Rating (A)	Handle colour	Reference
800 - 1800	Black	3999 <b>6203</b>



access\_156\_a\_2\_cat

### External handle

Front operation Rating (A)	Type of handle	Handle colour	External IP	Reference
800 ... 1800	S3	Black	IP55	1431 <b>3511</b>
800 ... 1800	S3	Red	IP55	1432 <b>3511</b>



access\_151\_a\_1\_cat



access\_166\_a\_2\_cat

Handle type S3

Handle type S3

### Type S handle adapter

#### Use

Enables S-type handles to be fitted in place of existing older style Socomec handles.

#### Dimensions

Adds 12 mm to the handle depth.

Handle colour	To be ordered in multiples of	External IP <sup>(1)</sup>	Reference
Black	1	IP65	1493 <b>0000</b>

(1) IP: protection index according to IEC 60529.



access\_187\_a\_1\_cat

### Alternative colour Type S handle cover

#### Use

For single lever S3 type handles.

Other colours available - please contact us.

Colour	To be ordered in multiples of	Handle	Reference
Light grey	50	Type S3	1401 <b>0001</b>
Dark grey	50	Type S3	1401 <b>0011</b>



access\_156\_a\_2\_cat

# COMBINED SIDERMAT DIN

Fuse combination switches with tripping function  
from 800 A to 1800 A

## Shaft for external operation

### Use

Standard lengths: Other lengths available - please contact us.  
- 200 mm  
- 320 mm.

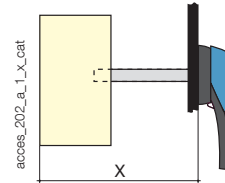

### Front operation

Rating (A)	Side X (mm)	Shaft length (mm)	Type	Reference
800	350 ... 450	200	15 x 12	1401 1520
800	350 ... 570	320	15 x 12	1401 1532
1250 ... 1800	370 ... 570	320	15 x 12	1401 1532

## Auxiliary contact

### Use

Pre-break and signalling of positions 0 and I: 1 to 2 NO/NC auxiliary contacts.

### Coil tripping

1 to 2 NO/NC auxiliary contacts.

### Connection to the control circuit

By 6.35 mm fast-on terminal.

### Characteristics

NO/NC auxiliary contact IP2.

### Electrical characteristics

30,000 operations.

## NO/NC position contact

Rating (A)	Current Nominal (A)	Operating current I <sub>e</sub> (A)			
		250 VAC AC-13	400 VAC AC-13	24 VDC DC-13	48 VDC DC-13
800 ... 1800	16	12	8	14	6

## NO/NC coil trip signalling

Rating (A)	Current Nominal (A)	Operating current I <sub>e</sub> (A)			
		250 VAC AC-13	400 VAC AC-13	24 VDC DC-13	48 VDC DC-13
800 ... 1800	16	12	8	12	2

## NO/NC changeover contact

Rating (A)	Auxiliary Contact position	Reference
800 ... 1800	1 <sup>st</sup> auxiliary contact	3999 0051
800 ... 1800	2 <sup>nd</sup> auxiliary contact	3999 0052

## NO/NC low level position contact

Rating (A)	Auxiliary Contact position	Reference
800 ... 1800	1 <sup>st</sup> auxiliary contact	3999 0111
800 ... 1800	2 <sup>nd</sup> auxiliary contact	3999 0112

## NO/NC coil trip signalling

Rating (A)	Auxiliary Contact position	Reference
800 ... 1800	1 <sup>st</sup> auxiliary contact	3999 0031

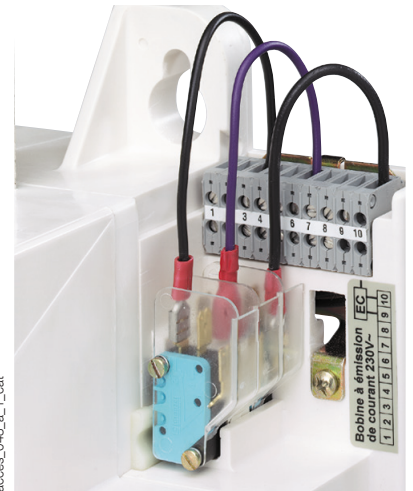

# COMBINED SIDERMAT DIN

Fuse combination switches with tripping function  
from 800 A to 1800 A

## Accessories (continued)

### Tripping coil.

#### Shunt trip coil

Voltage	Replacement coil Reference	Modification of original coil Reference
24 VAC	3990 1024	3991 1024
48 VAC	3990 1048	3991 1048
110 VAC	3990 1110	3991 1110
230 VAC	3990 1220	included
400 VAC	3990 1380	3991 1380
12 VDC	3990 2012	3991 2012
24 VDC	3990 2024	3991 2024
48 VDC	3990 2048	3991 2048
110 / 200 VDC	3990 2220	3991 2220
220 VDC	3990 2220	

#### Undervoltage trip coil

Voltage	Replacement coil Reference	Modification of original coil Reference
24 VAC	3990 3024	3991 3024
48 VAC	3990 3048	3991 3048
110 VAC	3990 3110	3991 3110
230 VAC	3990 3220	3991 3220
400 VAC	3990 3380	3991 3380
12 VDC	3990 4012	3991 4012
24 VDC	3990 4024	3991 4024
48 VDC	3990 4048	3991 4048
110 VDC	3990 4110	3991 4110
220 VDC	3990 4220	3991 4220

#### Use

Omnipolar breaking remotely controlled by a shunt trip or undervoltage release coil.

Note: the shunt trip coil must not be supplied for more than 5 s.

Coil mounted as standard on the device: shunt trip coil. To modify the coil, order one of the references opposite with the device.

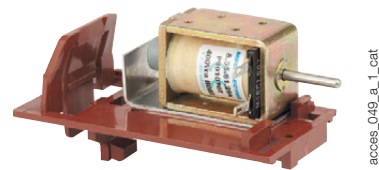

access\_049\_a\_1\_cat

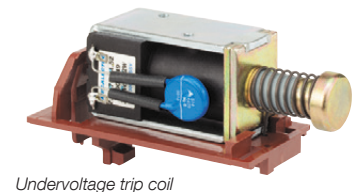

access\_050\_a\_1\_cat

### Current-reducing resistor for undervoltage trip coil

#### Use

By limiting the current, the resistor reduces the effects on undervoltage trip coils used in continuous processes or those exposed to high ambient temperatures.

Voltage	Reference
110 VAC	3999 3112
230 VAC	3999 3230
400 VAC	3999 3400
110 VDC	3999 4110

### Terminal screen

#### Use

Top and bottom protection from direct contact with terminals or connection parts.

Rating (A)	No. of poles	Position	References
800-1600	3 P	Top	2998 3120
800-1600	4 P	Top	2998 4120
1800	3 P	Top	2998 3180
1800	4 P	Top	2998 4180
800 ... 1800	3/4 P	Bottom	included

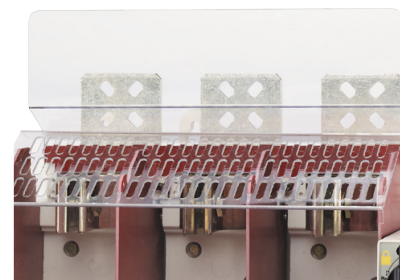

fusom\_059\_a\_1\_cat

# COMBINED SIDERMAT DIN

Fuse combination switches with tripping function  
from 800 A to 1800 A

## Inter-phase barrier

### Use

Safety isolation between the terminals, essential for use at 690 VAC or in a polluted or dusty atmosphere.

Rating (A)	No. of poles	Reference
800 ... 1800	3 P	2998 <b>0003</b>
800 ... 1800	4 P	2998 <b>0004</b>



access\_036\_a\_1\_cat

## Key handle interlocking system

### Use

- Locking in position 0 of the front operation handle:
- Using a padlock (not supplied) and standard padlocking function of the handle
- Using RONIS 1104 A lock (key BC 3318) to be mounted directly on the padlockable handle
- Using CASTELL K lock (not supplied)
- Using RONIS EL11AP lock (not supplied)

### Locking using RONIS EL 1104 A lock (supplied)

Rating (A)	Control	Reference
800 ... 1800	front direct	3999 <b>8104</b>

### Locking using RONIS EL11AP lock (not supplied)

Rating (A)	Control	Reference
800 ... 1800	External	1499 <b>7701</b>
1600 ... 1800	front direct	3999 <b>6117<sup>(1)</sup></b>

### Locking using CASTELL K (not supplied)

Rating (A)	Control	Reference
800 ... 1250	External	1499 <b>7702</b>

(1) For SIDERMAT fuse-combination switches only

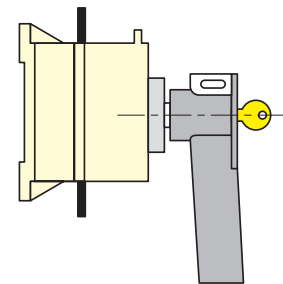

RONIS 1104 A lock.

access\_010\_b\_1\_x\_cat

## Label

### Use

Customisable self-adhesive label allowing identification of the devices.

Dimensions W x H (mm)	Available for order in multiples of	Reference
18 x 13	50	7769 <b>9999</b>



access\_044\_a\_1\_cat

## Other specific accessories

### Use

- Customised protection screens (for specific dimensions or high ambient temperatures).
- Connection accessories.
- Mounting plates for standard racks
- For specific atmospheric conditions.

# COMBINED SIDERMAT DIN

Fuse combination switches with tripping function  
from 800 A to 1800 A

## Dimensions

### COMBINED SIDERMAT fuse combination switches 800 to 1250 A

Direct front operation

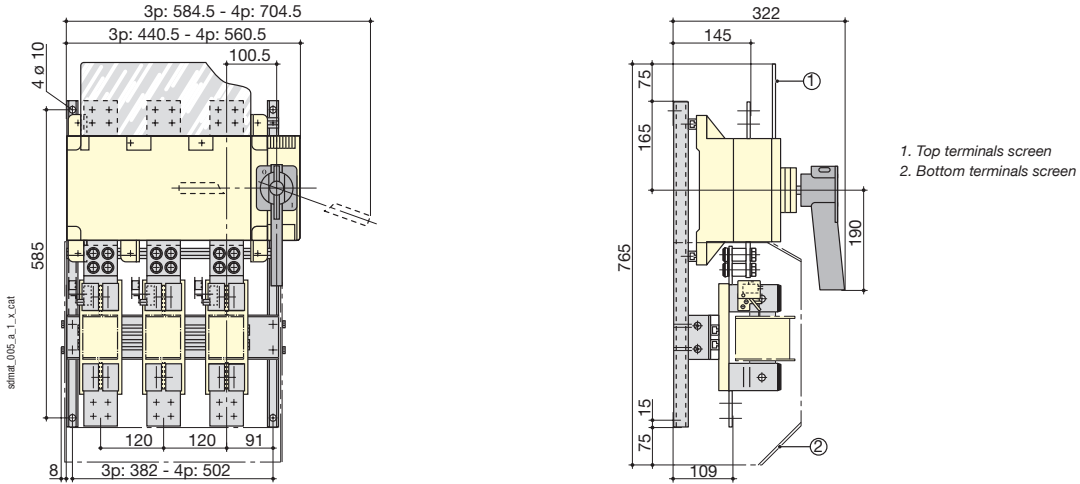

### COMBINED SIDERMAT fuse combination switches 1600 A

Direct front operation

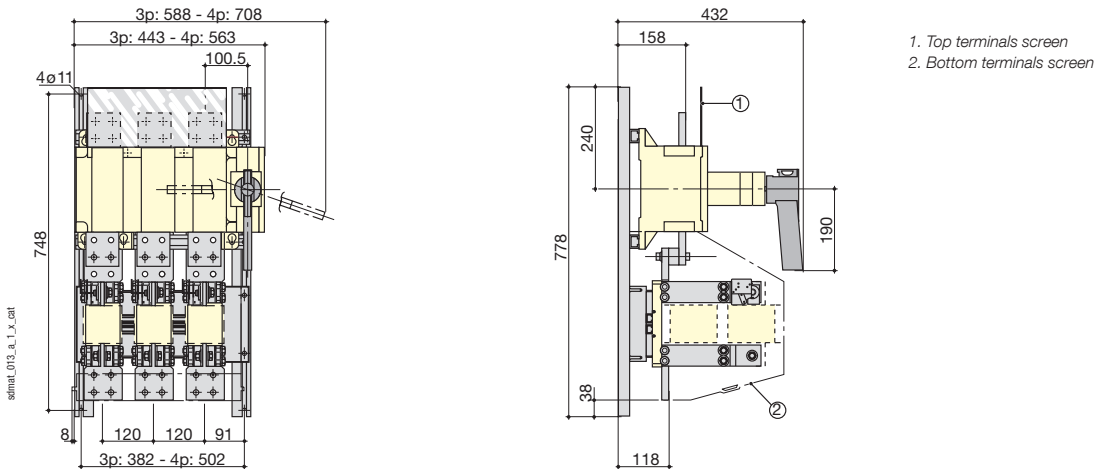

# COMBINED SIDERMAT DIN

Fuse combination switches with tripping function  
from 800 A to 1800 A

## COMBINED SIDERMAT fuse combination switches 1800 A

Direct front operation

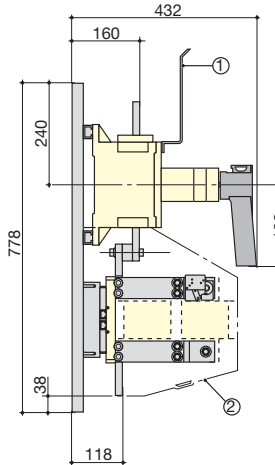
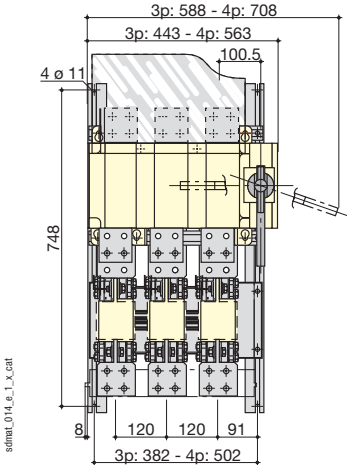

- 1. Top terminals screen
- 2. Bottom terminals screen

## Connection terminal

### COMBINED SIDERMAT fuse combination switches

800 to 1250 A

Top and bottom

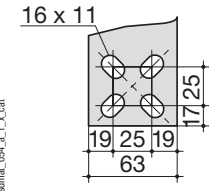

1600 A

Top

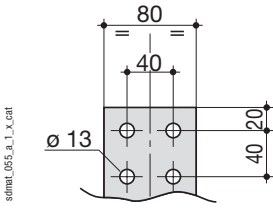

1800 A

Top

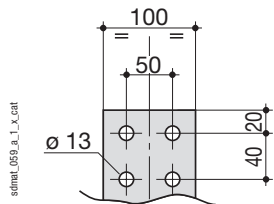

1600 to 1800 A

Bottom

