

Mounting rails and profiles

Mounting accessories

Enclosures
& accessories



elcha_039

The solution for

> Any electrical device



Conformity to standards

> EN 60715

Function

SOCOMECC **frame parts** come in steel, 304 L stainless steel or aluminium (profiles and accessories) and allow the fixing of any electrical equipment.

Configurations

Composition of the range:

1. Profile C 20 x 14 - 30 x 15 - 35 x 35
2. Diamond shaped nut 33 x 11 - 34 x 20
3. Bracket 45 x 60 x 25
- 2 oblong holes: 35 x 9 ou 25 x 9
4. Rectangular nut 28 x 35
5. Profile C 30 x 15
6. Square nut 25 x 25
7. Bracket 25 x 25 x 19
8. Square nut 15.5 x 15.5
9. Fixomega
10. Bracket 36 x 36 x 23
11. Terminal block support
12. Fixocap
13. Asymmetrical profile
14. Straddle bracket 30 x 15
15. Cable support rail
16. Straddle bracket 20 x 14
17. Straddle bracket 35 x 35

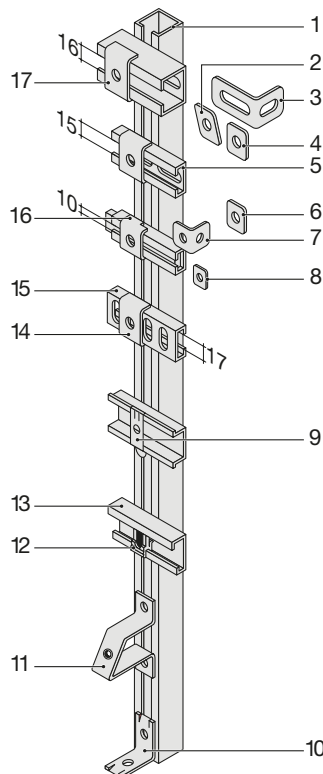

elcha_003_c_1_x_cat

■ Profile C

W x H x e (mm)	Perforations (mm)	Perforation centres (mm)	Material	Profiles length (m)	To be ordered in multiples of	Reference
20 x 14 x 1.5	8.2 x 40	50	Steel z-b ⁽¹⁾	3	30 m	5000 0120
30 x 15 x 1.5	8.2 x 40	50	Steel z-b ⁽¹⁾	3	30 m	5000 0121
35 x 35 x 2	8.2 x 40	50	Steel z-b ⁽¹⁾	2	12 m	5000 0132
35 x 35 x 2	8.2 x 40	50	Steel z-b ⁽¹⁾	3	18 m	5000 0122
30 x 15 x 1.5	6.3 x 18	50	Stainless steel	2	10 m	5000 1021
20 x 15 x 2	without		Aluminium	2	10 m	SA12 4202
20 x 15 x 2	without		Aluminium	3	15 m	SA13 4202
20 x 15 x 2	without		Aluminium	6	30 m	SA10 4202
29 x 19 x 2.5	without		Aluminium	2	10 m	SA12 4201
29 x 19 x 2.5	without		Aluminium	3	15 m	SA13 4201
29 x 19 x 2.5	without		Aluminium	6	30 m	SA10 4201

(1) White zinc-coated.

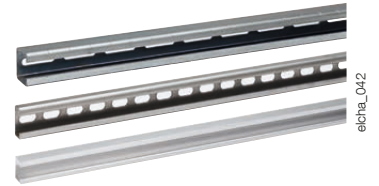

Accessories

Screws

Type	Insert M	Dimensions H x W (mm)	For profiles	To be ordered in multiples of	Reference
Square nut	M3	15.5 x 15.5	20 x 14	100	5000 0023
Square nut	M4	15.5 x 15.5	20 x 14	100	5000 0024
Square nut	M5	15.5 x 15.5	20 x 14	100	5000 0025
Square nut	M6	15.5 x 15.5	20 x 14	100	5000 0026
Square nut	M8	15.5 x 15.5	20 x 14	100	5000 0028
Square nut	M8	25 x 25	30 x 15	100	5000 0029
Rectangle nut	M8	35 x 28	35 x 35	100	5000 0037
Rectangle nut	M10	35 x 28	35 x 35	100	5000 0039
Rhomboidal nut	M3	33 x 11	30 x 15	100	5000 0033
Rhomboidal nut	M4	33 x 11	30 x 15	100	5000 0034
Rhomboidal nut	M5	33 x 11	30 x 15	100	5000 0035
Rhomboidal nut	M6	34 x 20	35 x 35	100	5000 0036
Rhomboidal nut	M8	34 x 20	35 x 35	100	5000 0038
Straddle bracket	Ø 8.2		20 x 14	100	5000 0010
Straddle bracket	Ø 8.2		30 x 15	100	5000 0011
Straddle bracket	Ø 8.2		35 x 35	100	5000 0012

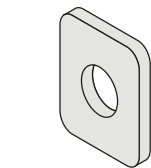

elcha_016_a_1_x_cat

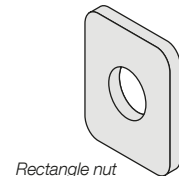

elcha_017_a_1_x_cat

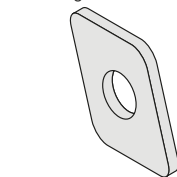

elcha_018_a_1_x_cat

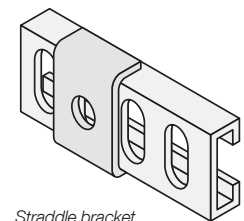

elcha_020_a_1_x_cat

Mounting rails and profiles

Mounting accessories

Symmetrical DIN rail

W x H x e (mm)	Perforations (mm)	Perforation centres (mm)	Material	Profiles length (m)	To be ordered in multiples of	Reference
35 x 7.5 x 1	Without		Steel z-b ⁽¹⁾	2	30 m	5000 0302
35 x 7.5 x 1	6.3 x 18	25	Steel z-b ⁽¹⁾	2	30 m	5000 0042
35 x 7.5 x 1	Without		Stainless steel	2	10 m	5000 1302

(1) White zinc-coated.

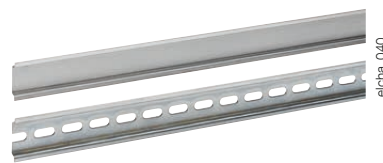

elcha_040

Symmetrical DIN rail

W x H x e (mm)	Perforations (mm)	Perforation centres (mm)	Material	Profiles length (m)	To be ordered in multiples of	Reference
35 x 15 x 1.5	Without		Steel z-b ⁽¹⁾	2	30 m	5000 0301
35 x 15 x 1.5	Without		Steel z-b ⁽¹⁾	3	30 m	5000 0331
35 x 15 x 2.3	Without		Steel z-b ⁽¹⁾	2	20 m	5000 0017
35 x 15 x 2.3	Without		Steel z-b ⁽¹⁾	3	30 m	5000 0027
35 x 15 x 1.5	6.3 x 18	25	Steel z-b ⁽¹⁾	2	30 m	5000 0043
35 x 15 x 1.5	6.3 x 18	25	Steel z-b ⁽¹⁾	3	30 m	5000 0343
35 x 15 x 2.5	Without		Aluminium	2	12 m	SA12 4217
35 x 15 x 2.5	Without		Aluminium	3	18 m	SA13 4217
35 x 15 x 2.5	Without		Aluminium	6	36 m	SA10 4217

(1) White zinc-coated.



elcha_043

Assymetrical G-section DIN rail

W x H x e (mm)	Perforations (mm)	Perforation centres (mm)	Material	Profiles length (m)	To be ordered in multiples of	Reference
32 x 15 x 1.5	Without		Steel z-b ⁽¹⁾	2	30 m	5000 0307
32 x 15 x 1.5	Without		Steel z-b ⁽¹⁾	3	30 m	5000 0308
32 x 15 x 1.5	6.3 x 18	25	Steel z-b ⁽¹⁾	2	30 m	5000 0044
32 x 15.5 x 1.5	Without		Aluminium	2	8 m	SA12 4210
32 x 15.5 x 1.5	Without		Aluminium	3	12 m	SA13 4210
32 x 15.5 x 1.5	Without		Aluminium	6	24 m	SA10 4210

(1) White zinc-coated.



elcha_041

Accessories

Fixomega / Fixocap

Type	Insert M	To be ordered in multiples of	Reference
Fixomega ⁽¹⁾	M4	100	5000 0041
Fixomega ⁽¹⁾	M5	100	5000 0051
Fixocap ⁽²⁾	M3/M5	100	5800 0003
White Fixocap ⁽²⁾	M4 / M6	100	5800 0005
Black Fixocap ⁽²⁾	M3/M5	100	5800 0004
Grey Fixocap ⁽²⁾	M4 / M6	100	5800 0006

(1) Clip-on nut for symmetrical profiles.

(2) Clip-on nut for asymmetrical profiles.

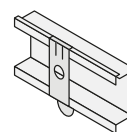

Fixomega

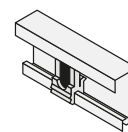

Fixocap

elcha_019_b_1_x_cat

Support for inclined mounting

Type	Number of holes	Ø hole (mm)	Insert M	To be ordered in multiples of	Reference
Support for inclined mounting	2	7	M5	10	5000 0100

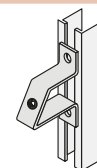

elcha_022_a_1_x_cat

Cable support rail

W x H x e (mm)	Perforations (mm)	Perforation centres (mm)	Material	Profiles length (m)	To be ordered in multiples of	Reference
30 x 15 x 1	8.2 x 14.5	16.7	Galvanised steel	3	15 m	5000 4325
50 x 12 x 1	8.2 x 14.5	16.7	Galvanised steel	2	20 m	5000 4326



elcha_033

L profile

W x H x e (mm)	Ø perforations (mm)	Perforation centres (mm)	Material	Profiles length (m)	To be ordered in multiples of	Reference
30 x 30 x 2.5	8.2	25	Steel z-b ⁽¹⁾	2	10 m	5254 6401
30 x 50 x 2.5	8.2	25	Steel z-b ⁽¹⁾	2	10 m	5254 6501
30 x 30 x 2.5	8.5 x 45	55	Steel z-b ⁽¹⁾	2	10 m	5000 0003
40 x 40 x 2.5	8.5 x 45	55	Steel z-b ⁽¹⁾	2	10 m	5000 0004

(1) White zinc-coated.

U profile

W x H x e (mm)	Ø perforations (mm)	Perforation centres (mm)	Material	Profiles length (m)	To be ordered in multiples of	Reference
50 x 30 x 2.5	8.2	25	Steel z-b ⁽¹⁾	2	10 m	5254 6701
30 x 20 x 3	9	25	Aluminium	3	3 m	5254 6901

(1) White zinc-coated.

Z profile

W x H x e (mm)	Ø perforations (mm)	Perforation centres (mm)	Material	Profiles length (m)	To be ordered in multiples of	Reference
30 x 30 x 2.5	8.2	25	Steel z-b ⁽¹⁾	2	10 m	5254 6601

(1) White zinc-coated.

Rising U

W x H x e (mm)	Ø perforations (mm)	Perforation centres (mm)	Material	Profiles length (m)	To be ordered in multiples of	Reference
30 x 50 x 2.5	8.2 x 45	55	Steel z-b ⁽¹⁾	2	8 m	5000 0005

(1) White zinc-coated.



elcha_034

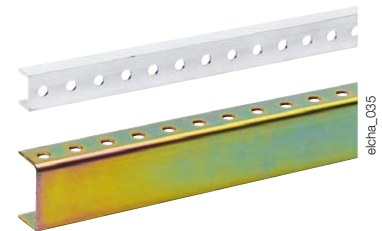

elcha_035

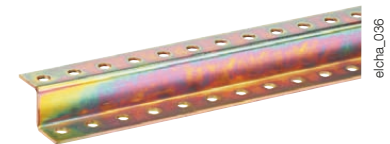

elcha_036

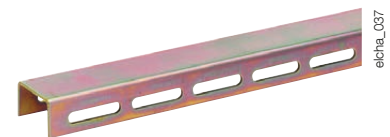

elcha_037

Accessories

Bracket

Use

For steel profile.

Characteristics

Bichromate zinc-coated steel.

H x W x D (mm)	Number of holes	Ø hole (mm)	Insert M	To be ordered in multiples of	Reference
25 x 25 x 19	2	7		25	5000 0045
25 x 25 x 19	1	6	M6	25	5000 0046
36 x 36 x 23	2	8		25	5000 0047
45 x 60 x 25	2	9x25 / 9x35		25	5254 6101
44 x 75 x 32	5	5 / 6		1 (Set of 6)	5119 5045

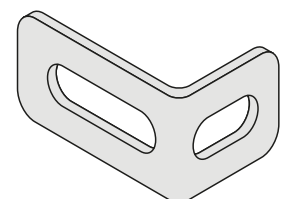

elcha_021_a_1_x_cat

Screws

Use

For steel profile.

Characteristics

Bichromate zinc-coated steel.
Integrated washer

Thread	L (mm)	Class	To be ordered in multiples of	Reference
M6	10	8.8	100	5000 0066
M8	12	8.8	100	5000 0068
M8	16	8.8	100	5000 0069

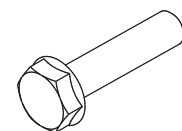

elcha_038_a_1_x_cat

Washer

Use

For steel profile.

Characteristics

Bichromate zinc-coated steel.

Ø x e (mm)	Ø hole (mm)	To be ordered in multiples of	Reference
16 x 1.5	6.5	100	5000 0015
19 x 1.5	6.5	100	5000 0018
22 x 1.5	8.5	100	5000 0016



amc_035_a_1_x_cat

PVC border

Use

PVC border for sheet metal.

Characteristics

Colour: Light grey

Steel thickness (mm)	To be ordered in multiples of	Reference
2	25 m	7739 0025

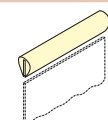

amc_036_a_1_x_cat